

NATIONAL INSTITUTE FOR EMPOWERMENT OF PERSONS
WITH MULTIPLE DISABILITIES (DIVYANGJAN), (NIEPMD)

(Department of Empowerment of Persons with Disabilities,
Ministry of Social Justice & Empowerment, Govt. of India)
E.C.R. Muttukadu Kovalam P.O, Chennai- 603 112

Tender No. NIEPMD/Pur 4 (13)/2021-22
Notice Inviting Tenders: NIEPMD & Its CRCs
Sub.: Annual Rate Contract for Purchase of
Prosthetics & Orthotics (P&O) Components /Kits & Raw Materials

National Institute for Empowerment of Persons with Multiple Disabilities (NIEPMD), Chennai, Under Ministry of Social Justice and Empowerment, DEPwD intends to enter in to annual rate contract for a period of one year after finalization of contract. The contract may be extendable up to 02 more years subject to satisfactory performance and discretion of Director, NIEPMD. However, it is not binding for either side to extend the rate contract beyond one year. The material is meant for free of cost distribution to the persons with disabilities (PwDs.) beneficiaries under ADIP Scheme. The following terms and conditions will be followed for procurement of **“Prosthetics & Orthotics (P&O) Components /Kits & Raw Materials”** for use in P&O Martials Development Unit of NIEPMD & CRCs:

1. Tentative purchase amount for one year Rs 15.00 lacs. (May be increased or decreased as per NIEPMD programme requirement. Purchase amount may be NIL also during the year or currency of contract subject to requirement and avability of funds. No claim for minimum purchase will be entertained.
2. **Submission of Bid:** The bid should be uploaded through NIC e-procurement portal URL [“http://eprocure.gov.in/eprocure/app”](http://eprocure.gov.in/eprocure/app) up to **06th Dec 2021 at 03.00 PM, containing following:**
 - i) EMD in the manner as prescribed at Clause No.11 below.
 - ii) Bidder shall upload the scanned copies of following:
 - a) Authorized Dealer/Distributor/Business Partner/RSR Certificate from OEM.
 - b) Relevant Documents in case of MSME/SSI/NSIC Unit.
 - c) PAN Card, Address Proof and Sales Tax/TIN No.
 - d) GSTIN number certificate
 - e) BIS / ISI certification for quoted products if available. Wherever ISI / BSI certified product available, priority will be given to those product vendors only.
 - iii) Duly filled Price Bid (BOQ Provided in Excel format).

--Sd/--

DR (Admin. Offg.)
Date: 12th Nov 2021

--Sd/--

Director, NIEPMD

3. **Opening of Bid:** Technical Bid shall be opened on the **07th Dec 2021 at 04.00 PM.**
4. **Bid Validity:** Bid shall remain valid for a period of 60 days from the date of opening of bid.
5. **Bid Evaluation:** Duly filled Price Bid shall be evaluated on lowest items basis.
6. The total cost quoted should be exclusive of taxes. Applicable taxes to be mentioned separately. Tax applicable at the time of invoice will be paid. Rate quoted inclusive of taxes will not accepted such bids will not be considered for evaluation. Tax Rate quoted as ZERO will not be accepted (If material is not declared as Tax free by Govt. / GST Council). NIEPMD GSTIN number should be used for Tax invoice purpose.
7. Prices quoted by the bidder shall remain FIRM for delivery in NIEPMD, Chennai and its CRCs/RCs/Extn. Centers etc. during the currency of contract and any extension thereof.
8. The tender submitted by any other means except NIC e-procurement portal, will not be entertained under any circumstances.
9. The list of technically qualified bidders will be published CPP portal automatically after evaluation of technical bids.
10. The financial bids of technically qualified bidders only will be opened after technical evaluation of bids as per date and time fixed on CPP portal.
11. **Earnest Money Deposit:** The Bidders shall deposit Earnest Money amounting to **Rs. 50,000.00 (Rs. Fifty Thousand only)** and non-refundable tender fees of **Rs. NIL** through e-payment as per the procedure mentioned below:

11.1 Procedure for e-payment:

EMD of Rs. 50,000/- should be paid online through NEFT or RTGS in NIEPMD account and payment receipt to be uploaded with technical bid. Technical bids without EMD shall not be considered for further evaluation. NIEPMD Bank details are as follows:

A/C No. 761297290

Type of Account: Saving Bank

Name of Bank: Indian Bank, Kovalam Branch

IFS Code: IDIB000K122

Branch Code: 01176

• **Caution:** Please ensure that you need to mention the correct beneficiary account number and IFSC code as mentioned above while making payment via RTGS /

NEFT. In the event of funds remitted to wrong beneficiary account number, NIEPMD, Chennai or its Bank would not responsible for the same.

12. Tender Submission process

Interested bidder may submit their quotes by giving all the necessary documents in English or Hindi as specified. **The TENDER must be submitted online through Central Public Procurement Portal e-procurement application only through URL: <http://eprocure.gov.in/eprocure/app> only.** No manual bids will be entertained under any circumstances.

The Tender document attached must be direct, concise, and complete and arranged in an organized and structured manner.

To participate in online bidding process, Bidders must procure a Digital Signature Certificate as per Information Technology Act-2000 using which they can digitally sign and encrypt their electronic bids. Bidders can procure the same from any CCA approved certifying agency, i.e. TCS, Safecrypt, Ncode, eMudhra etc. Bidders who already have a valid Digital Signature Certificate (DSC) need not procure a new DSC.

NIEPMD will not be responsible for delay in online submission due to any reason. For this, bidders are requested to upload the complete bid proposal well advance in time so as to avoid issues like slow speed, choking of web site due to heavy load or any other unforeseen problems.

Bidders are also advised to refer visit any local NIC office or call CPPP 24x7 toll free number 1800-3070-223 or mobile No. 07878007972, 07878007973 for further details about the e-tendering / bidding process.

GENERAL TERMS AND CONDITIONS:

13. The bid is liable to be rejected if the EMD is not found in order or receipt not accompanying with the Technical Bid.
14. The EMD of unsuccessful bidders shall be returned after the issuance of award to the successful bidder. No interest shall be paid by the NIEPMD, Chennai on the EMD.
15. The EMD of successful bidders shall be retained as security deposit and released after successful completion of contract. No interest will be paid on EMD amount.

16. NIEPMD reserves the right to accept / reject / select more than one Agency and to annul the bidding process of any or all bids at any time prior to award of contract without thereby incurring any liability to the affected bidders.
17. The NIEPMD reserves the right to increase/decrease the quantity at the time of placing the order.
18. The order will be awarded for supply of P & O components & Raw Materials / Kits with the lowest item rate basis from the technically qualified bidder. **As no subsequent cost negotiations will be done, the price quoted should be final.**
19. In case **07th Dec 2021** happens to be holiday, the tenders shall be opened on next working day at the same time and place.
20. NIEPMD will not provide 'C' and 'D' Form.
21. **Submission of bid means that bidder has read all the terms and conditions of this NIQ carefully and will comply them all unconditionally. Conditional bids will not be accepted.**
22. NIEPMD, Chennai reserves the right to split the quantity/items ordered on more than one vendor.
23. **Approximate requirement for one year:-**
Attached as Appendix "A" to this document.
24. The tender will be appraised by NIEPMD Purchase Committee and Officer Incharge Martial Development- (Aids & Appliance).
25. **MSME/SSI Units:** The units registered with MSME/SSI/NSIC, are exempted from payment of EMD subject to following: (However no agency is exempted from paying of security deposit).
 - I. Submission/upload of registration certificate with District Industries Centers or Khadi and Village Industries Commission or Khadi and Village Industries Board or National Small Industries Corporation
 - II. Valid registration during validity period of quotation.
 - III. Applied for registration or for renewal will not be accepted. Such offers will be treated as offer received without EMD
26. The award to MSME Firms shall be regulated as per Govt. Guidelines.
27. **Delivery Schedule:** Purchase order shall be issued as per requirement and the firm shall ensure delivery of material within 15 days from the date of placement of each purchase order.
28. **Payment:** payment will be made after receipt of material against each Purchase Order in good condition and full quantity to the entire satisfaction of Consignee.

Normally payment will be made within thirty working days after satisfactory receipt of materials. No advance payment under any circumstances will be made.

29. Delayed delivery & Compensation for delay:

If the delivery of material/goods in full and in good condition is not completed for whatsoever reason within the stipulated period, an amount @5% (Five percent of the undelivered material) would be deducted from the payment due to supplier for each week or part thereof, subject to the maximum of 25% (Twenty five percent of the undelivered material). In case, short supply in all respect is delayed beyond 70 days of scheduled delivery period in that case besides LD, EMD shall also be forfeited without any notice.

Further if the delivery of material/goods is not commenced at all for whatsoever reason within the scheduled delivery period, in that case the NIEPMD reserve the right to cancel the order with forfeiture of security deposit without any notice.

In case of any defects and material is not found to be as per specification, the same shall be made good/replaced by the concerned firm as per the instructions of Consignee failing which it will attract action as above.

29. The NIEPMD reserves the right to accept or reject any or all the tenders without assigning any reason thereof whatsoever.

.....We agree to all terms and conditions as mentioned above including the validity of the offer. Utmost confidentiality of the data provided shall be maintained.

Name, Designation & Signature of the bidder with the seal

NATIONAL INSTITUTE FOR EMPOWERMENT OF PERSONS WITH MULTIPLE DISABILITIES (NIEPMD)

(Department of Empowerment of Persons with Disabilities,
Ministry of Social Justice & Empowerment, Govt. of India)
East coast Road, Muttukadu, Kovalam (post) Chennai-603 112
[Tel:044-27472113,27472046](tel:044-27472113,27472046) Fax:044-27472389
www.niepmd.tn.nic.in Email:niepmd@mail.com

TECHNICAL BID

(To be uploaded)

Name and address of the bidder:



1. Name of the bidder
 - a) Full postal address
 - b) Full address of the premises
 - c) Telegraphic address
 - d) Telex number
 - e) Telephone number
 - f) Fax number
2. Monthly supply capacity of goods quoted for
 - a) Normal
 - b) Maximum
3. Total average annual turn-over of last 05 FYs (value in Rupees).....
(Copy of Balance Sheet s Audit Statement / IT returns, etc. to be attached as proof)
4. Past supply details for 3 years (major orders only)





5. Whether similar job work undertaken in the past, if so details
(Samples to be displayed if required)

Customer **Quantity supplied** **Year**





Information to be furnished for the Technical bid for “Prosthetics & Orthotics Components & Raw Materials” for Rate Contract: -





SL NO.	NAME OF MATERIAL	PICTURE	TECHNICAL SPECIFICATION	Proposed Annual Requirement
1.	Cotton Tubular Stockinette		1. Made of fine quality (100%) cotton; 2. Skin free irritation; 3. Shrink resistant; 4. Size: 200 mm; 5. Colour: skin tone	20 Rolls (1 roll= 10 mtr.)
2.	Cotton Tubular Stockinette		1. Made of fine quality (100%) cotton; 2. Skin free irritation; 3. Shrink resistant; 4. Size: 120 mm; 5. Colour: skin tone	30 Rolls (1 roll= 10 mtr.)
3.	Cotton Tubular Stockinette		1. Made of fine quality (100%) cotton; 2. Skin free irritation; 3. Shrink resistant; 4. Size: 100mm; 5. Colour: skin tone	40 Rolls (1 roll= 10 mtr.)
4.	Cotton Tubular Stockinette		1. Made of fine quality (100%) cotton; 2. Skin free irritation; 3. Shrink resistant; 4. Size: 80mm; 5. Colour: skin tone	150 Rolls (1 roll= 10 mtr.)
5.	Cotton Tubular Stockinette		1. Made of fine quality (100%) cotton; 2. Skin free irritation; 3. Shrink resistant; 4. Size: 60mm; 5. Colour: skin tone	150 Rolls (1 roll= 10 mtr.)
6.	Cotton Tubular Stockinette		1. Made of fine quality (100%) cotton; 2. Skin free irritation; 3. Shrink resistant; 4. Size: 30mm; 5. Colour: skin tone	75 Rolls (1 roll= 10 mtr.)
7.	Cotton Tubular Stockinette		1. Made of fine quality (100%) cotton; 2. Skin free irritation; 3. Shrink resistant; 4. Size: 180mm; 5. Colour: skin tone	50 Rolls (1 roll= 10 mtr.)

8.	Cotton Tubular Stockinette		1. Made of fine quality (100%) cotton; 2. Skin free irritation; 3. Shrink resistant; 4. Size: 300mm; 5. Colour: skin tone	20 Rolls (1 roll= 10 mtr.)
9.	Nylon Tubular Stockinette		1. Made of fine quality (100%) nylon; 2. Skin free irritation; 3. up to 300% stretches; 4. Size: 200mm; 5. Colour: White	30 Rolls (1 roll= 10 mtr.)
10.	Nylon Tubular Stockinette		1. Made of fine quality (100%) nylon; 2. Skin free irritation; 3. up to 300% stretches; 4. Size: 120mm; 5. Colour: White	30 Rolls (1 roll= 10 mtr.)
11.	Nylon Tubular Stockinette		1. Made of fine quality (100%) nylon; 2. Skin free irritation; 3. up to 300% stretches; 4. Size: 100mm; 5. Colour: White	75 Rolls (1 roll= 10 mtr.)
12.	Nylon Tubular Stockinette		1. Made of fine quality (100%) nylon; 2. Skin free irritation; 3. up to 300% stretches; 4. Size: 80mm; 5. Colour: White	100 Rolls (1 roll= 10 mtr.)
13.	Nylon Tubular Stockinette		1. Made of fine quality (100%) nylon; 2. Skin free irritation; 3. up to 300% stretches; 4. Size: 60mm; 5. Colour: White	100 Rolls (1 roll= 10 mtr.)
14.	Nylon Tubular Stockinette		1. Made of fine quality (100%) nylon; 2. Skin free irritation; 3. up to 300% stretches; 4. Size: 30mm; 5. Colour: White	100 Rolls (1 roll= 10 mtr.)
15.	Plaster of Paris Bandage		1. Size: 4inch x 4.5 mtr.	600 Box (1 box= 12 nos.)
16.	Plaster of Paris Bandage		1. Size: 6inch x 4.5 mtr.	500 Box (1 box= 12 nos.)
17.	Plaster of Paris Powder		1. White colored powder; 2. Setting time: 3-5 minutes 3. Ortho Grade	1000 Kg (1 Kg packet)

18.	Fiberglass Stockinette		<ul style="list-style-type: none"> • For fabricating thin-walled laminates <ul style="list-style-type: none"> • Braiding • High torsional strength in laminates <ul style="list-style-type: none"> • Good draping characteristics <ul style="list-style-type: none"> • Size- 60 mm 	20 Rolls (10 mtr. Roll)
19.	Fiberglass Stockinette		<ul style="list-style-type: none"> • For fabricating thin-walled laminates <ul style="list-style-type: none"> • Braiding • High torsional strength in laminates <ul style="list-style-type: none"> • Good draping characteristics <ul style="list-style-type: none"> • Size- 80mm 	20 Rolls (10 mtr. Roll)
20.	Glass Fiber Cloth/ satin Type		<ul style="list-style-type: none"> • For partial laminate reinforcements • Good absorption of lamination resins <ul style="list-style-type: none"> • High strength • Good draping characteristics 	300Sq. Mt
21.	Carbon-Fibre Fabric		<ul style="list-style-type: none"> • For partial high-strength laminate reinforcements <ul style="list-style-type: none"> • Good absorption of lamination resins • Good draping characteristics <p>Size- Thickness- 1.5 mm</p>	250 Sq. Mt
22.	Carbon Fiber Webbing		<p>For partial high-strength, unidirectional laminate reinforcements. Large selection of different widths. Good absorption of all lamination resins</p> <p>Size- Thickness- 1.5mm; Width- 50mm</p>	20 Rolls (25 mtr. Roll)

23.	Woven Carbon-Fiberglass Stockinette		<ul style="list-style-type: none"> • For fabricating thin-walled laminates <ul style="list-style-type: none"> • Braiding • Combines the properties of carbon and fiberglass <ul style="list-style-type: none"> • Enhanced torsional strength in laminates • Torsion can be influenced by different circumferences (ideal angle 45°) <ul style="list-style-type: none"> • Size- 80mm 	25 roll (10 mtr. Roll)
24.	Polyester resin (GPR)		General Purpose Resin (Polyester Resin) for fabrication of plastic laminate prosthetic socket & plastic laminate orthosis.	100 Kg (25 kg Pkg.)
25.	Hardener (Promoters)		For General Purpose Resin (Polyester Resin)	5 Kg (1 kg pkg.)
26.	Catalyst		For General Purpose Resin (Polyester Resin)	5 Kg (1kg pkg)
27.	Epoxy Resin (Liquid)		For Fabric impregnate plastic Lamination for fabrication of plastic laminate prosthetic socket & plastic laminate orthosis	50 Kg (5 kg pkg.)
28.	Hardener		For epoxy resin	5 Kg (1 kg pkg)
29.	Pigment		Mid buff/Cinnamon/Skin colour	2 kg (½ Kg pkg.)



30.	Thinner		For softening PVC film 1 st Quality	100 liters (1 liter pkg.)
31.	Polyvinyl Chloride Film (PVC film)		1. For making PVC bag of B/K and A/K & other plastic laminate work; 2. Thickness- 0.5mm	1000 meters
32.	Insulation Tape		Poly vinyl Chloride material Color: different color	300 Pcs
33.	Vaseline/Petroleum Jelly		1. Domestic purpose; 2. Colour: Pale yellow	25 Kg (1/2 kg Packaging)
34.	Bee Wax		For making prosthetic check test socket	50 Kg (1Kg Pkg)





35.	PVA Bag for Trans Tibial and Trans radial Prosthesis lamination		Material- Polyvinyl Chloride plastic bag	500 Nos.
36.	PVA Bag for Trans Femoral and Trans Humeral and Shoulder disarticulation Prosthesis lamination		Material- Polyvinyl Chloride plastic bag	500 Nos.
37.	Sewing Thread Polyester		1. For Domestic purpose; 2. Colour: White; 3. Length: 1000 mtr.	50 Pieces/ Nos. (1 Piece- 1000 Mtr.)
38.	Hand Stitching Thread		1. Light weight Nylon or Poly Alteration Leather Thread; 2. Type: Filament Nylon or Polyester; 3. Size:46; 4. Colour: Black; 5. Length: 10,000 mtr.	50 pieces/Nos. (1 Piece- 10,000 Mtr.)
39.	Mochi Thread		For Manual stitching; Colour- Black Length- 1000 Mtr.	20 Pieces/Nos. (1 Piece- 1,000 Mtr.)
40.	Sewing Thread Cotton		1. For Domestic purpose; 2. Colour: Black; 3. Length: 10.5cm	35 Nos



	Black (Cone Type)			
41.	Sewing Thread Cotton Skin Colour (Cone Type)		1. For Domestic purpose; 2. Colour: Skin Colour; 3. Length- 1,000 Mtr.	30 Nos/Pieces (1 Piece- 1,000 Mtr.)
42.	Sewing Thread Cotton (Cylinder Type)		1. For Domestic purpose; 2. Colour: Black; 3. Length: 1000 Meter	25 Nos/Pieces (1 Piece-1,000 Mtr.)
43.	Sewing Thread Nylon (Cylinder Type)		1. For Domestic purpose; 2. Colour: White; 3. Length: 1000 Meter, bundle height- 5cm; 4. Lamination purpose	25 Nos/Pieces (1 Piece- 1,000 Mtr.)
44.	Aluminium Sheet		18 gauge Sheet size: 6feet x 4feet.	50 Sheet
45.	Aluminium Flat Bar		1. Size: Width x Thickness: 1'' x 3mm	50Mt
46.	Aluminium Flat Bar		1. Size: Width x Thickness: ¾ '' x 3mm	75Mt
47.	Aluminium Flat Bar		1. Size: Width x Thickness: ½ '' x 3mm	50Mt
48.	Aluminium Flat Bar		1. Size: Width x Thickness: 1'' x 5mm	75Mt





49.	Aluminium Flat Bar		1. Size: Width x Thickness: ¾ '' x 5mm	50Mt
50.	Cotton Webbing Strap		1. Material-Cotton; 2. Width: ½ ''; 3. Colour: White	200 Mtr. (10 Mtr. Roll)
51.	Cotton Webbing Strap		1. Material-Cotton; 2. Width: 1''; 3. Colour: White	200 Mtr. (10 Mtr. Roll)
52.	Cotton Webbing Strap		1. Material -Cotton; 2. Width: 1 1/2''; 3. Colour: White	200 Mtr. (10 Mtr. Roll)
53.	Cotton Webbing Strap		1. Material- Cotton; 2. Width: 2''; 3. Colour: White	300 Mtr. (10 Mtr. Roll)
54.	Metal Buckle with Roller and Single Prong		1. Material: Metal; 2. Colour: Black/Silver; 3. Size: Length x Width x Thickness: ½ '' x 3mm	200 packet (1packet-100 Nos.)
55.	Metal Buckle with Roller and Single Prong		1. Material: Metal; 2. Colour: Black/Silver; 3. Size: Length x Width x Thickness: 1 '' x 3mm	200 packet (1packet-100 Nos.)
56.	Metal Buckle with Roller and Single Prong		1. Material: Metal; 2. Colour: Black/Silver; 3. Size: Length x Width x Thickness: 1 1/2'' x 1'' x 3mm	200 packet (1packet-100 Nos.)
57.	Metal Buckle with Roller and Single Prong		1. Material: Metal; 2. Colour: Black/Silver; 3. Size: Length x Width x Thickness: 2'' x 1 ½'' x 3mm	100 packet (1packet-100 Nos.)
58.	Metal Oval 'O' ring loop		1. Material: Metal; 2. Colour: Silver; 3. Size: Length x Width x Thickness: ½ '' x 3/8'' x 10mm	200 packet (1packet-100 Nos.)





59.	Metal Oval 'O' ring loop		1. Material: Metal; 2. Colour: Silver; 3. Size: Length x Width x Thickness: 1" x 3/8" x 10mm	200 packet (1packet-100 Nos.)
60.	Metal Oval 'O' ring loop		1. Material: Metal; 2. Colour: Silver; 3. Size: Length x Width x Thickness: 1 1/2" x 3/8" x 10mm	200 packet (1packet-100 Nos.)
61.	Metal Oval 'O' ring loop		1. Material: Metal; 2. Colour: Silver; 3. Size: Length x Width x Thickness: 2" x 3/8" x 10mm	100 packet (1packet-100 Nos.)
62.	D- Ring –Semi-circular Type		1. Welded Steel; 2. Nickel Plated; 3. Size: Inside Flat-19mm, Inside Height- 16mm, Wire Diameter- 3mm, Width-1/2 "	200 packet (1packet-100 Nos.)
63.	D- Ring –Semi-circular Type		1. Welded Steel; 2. Nickel Plated; 3. Size: Inside Flat-25mm, Inside Height- 22mm, Wire Diameter- 5mm, Width-1"	200 packet (1packet-100 Nos.)
64.	D- Ring –Semi-circular Type		1. Welded Steel; 2. Nickel Plated; 3. Size: Inside Flat- 38mm, Inside Height- 28mm, Wire Diameter- 5mm, Width-1 1/2 "	200 packet (1packet-100 Nos.)
65.	D- Ring –Semi-circular Type		1. Welded Steel; 2. Nickel Plated; 3. Size: Inside Flat- 38mm, Inside Height- 28mm, Wire Diameter- 5mm, Width-2 "	100 packet (1packet-100 Nos.)
66.	Rectangular Ring Loop		1. Welded Steel; 2. Nickel Plated; 3. Size: Length -20mm, Width- 1/2 inch, Wire Diameter- 3mm	200 packet (1packet-100 Nos.)
67.	Rectangular Ring Loop		1. Welded Steel; 2. Nickel Plated; 3. Size: Length-25mm, Width- 1 inch, Wire Diameter- 3mm	200 packet (1packet-100 Nos.)
68.	Rectangular Ring Loop		1. Welded Steel; 2. Nickel Plated; 3. Size: Length- 38mm, Width- 1 1/2 inch, Wire Diameter- 5mm	200 packet (1packet-100 Nos.)

69.	Rectangular Ring Loop		1. Welded Steel; 2. Nickel Plated; 3. Size: Length- 50mm, Width- 2 inch, Wire Diameter- 5mm	100 packet (1packet-100 Nos.)
70.	Rivet Copper flat head		1. Material: Copper; 2. Head: Flat; 3. Size: Shaft length- 13mm, Shaft Diameter-3mm (1/8'')	10 Kg
71.	Rivet Copper flat head		1. Material: Copper; 2. Head: Flat; 3. Size: Shaft length- 19mm, Shaft Diameter-3mm (1/8'')	5 Kg
72.	Rivet Copper flat head		1. Material: Copper; 2. Head: Flat; 3. Size: Shaft length- 25mm, Shaft Diameter-3mm (1/8'')	5 Kg
73.	Rivet Copper flat head		1. Material: Copper; 2. Head: Flat; 3. Size: Shaft length- 19mm, Shaft Diameter-4mm (5/32'')	10 Kg
74.	Rivet Copper flat head		1. Material: Copper; 2. Head: Flat; 3. Size: Shaft length- 25mm, Shaft Diameter-4mm (5/32'')	5 Kg
75.	Rivet Copper flat head		1. Material: Copper; 2. Head: Flat; 3. Size: Shaft length- 25mm, Shaft Diameter-4.7mm (3/16'')	6 Kg
76.	Cooper Washer		Surface Finish- Metal Coated & Electroplated Thickness- 1.5 mm Inner Diameter- 3mm Outer Diameter- 10mm	1000 Nos. (1Pkt.-200 Nos.)



77.	Cooper Washer		Surface Finish- Metal Coated & Electroplated Thickness- 1.5 mm Inner Diameter- 4mm Outer Diameter- 10mm	1000 Nos. (1Pkt.-200 Nos.)
78.	Copper Washer		Surface Finish- Metal Coated & Electroplated Thickness- 1.5 mm Inner Diameter- 5mm Outer Diameter- 12mm	1000 Nos. (1Pkt.-200 Nos.)
79.	Rivet Aluminium flat head		1. Material: Aluminium; 2. Head: Flat; 3. Size: Shaft length- 19mm, Shaft Diameter-3mm (1/8'')	20 Kg
80.	Rivet Aluminium flat head		1. Material: Aluminium; 2. Head: Flat; 3. Size: Shaft length- 25mm, Shaft Diameter-4mm (5/32'')	20 kg
81.	Press Button		1. Material: Brass; 2. Shaft Length: 6mm; 3. Colour: Black/Silver	1000 Pairs
82.	Press Button		1. Material: Brass; 2. Shaft Length: 12mm; 3. Colour: Black/Silver	1000 Pairs
83.	Press Button		1. Material: Brass; 2. Shaft Length: 19mm; 3. Colour: Black/Silver	200 Pairs
84.	Nut & Screw		1. Material: Brass; 2. Shaft Length: 3/4 inch; 3. Diameter- 1/8'' 4. Colour: Silver	1000 Nos
85.	Nut & Screw		1. Material: Brass; 2. Shaft Length: 1 inch; 3. Diameter- 1/8'' 4. Colour: Silver	1000 Nos
86.	Nut & Screw		1. Material: Brass; 2. Shaft Length: 1/2 inch; 3. Diameter- 1/8'' 3. Colour: Silver	500 Nos





87.	Nut & Screw		1. Material: Brass; 2. Shaft Length: 1/2 inch; 3. Diameter- 5/32" 3. Colour: Silver	1000 Nos.
88.	Nut & Screw		1. Material: Brass; 2. Shaft Length: 1 inch; 3. Diameter- 5/32" 3. Colour: Silver	1000 Nos.
89.	Nut & Screw		1. Material: Brass; 2. Shaft Length: 3/4 inch; 3. Diameter- 5/32" 3. Colour: Silver	1000 Nos.
90.	Nut & Bolt with Washer		1. Material: Stainless steel, 2. Shaft Length: 2 inch; 3. Diameter- 5/32" 3. Colour: Silver	500 Nos.
91.	Velcro Hook & Loop Fasteners		1. Woven Hook & Loop 2. Base Material: Nylon/ Polyester 3. Colour: Black/White 4. Size: 1/2 -inch x 25 Mtr. roll 5. Application: Orthosis/ Prosthesis	50 Rolls (1 Roll- 25 Mtr.)
92.	Velcro Hook & Loop Fasteners		1. Woven Hook & Loop 2. Base Material: Nylon/ Polyester 3. Colour: Black/White 4. Size: 1-inch x 25 Mtr. roll 5. Application: Orthosis/ Prosthesis	100 Rolls (1 Roll- 25 Mtr.)
93.	Velcro Hook & Loop Fasteners		1. Woven Hook & Loop 2. Base Material: Nylon/ Polyester 3. Colour: Black/White 4. Size: 1 1/2 -inch x 25 Mtr. roll 5. Application: Orthosis/ Prosthesis	100 Rolls (1 Roll- 25 Mtr.)
94.	Velcro Hook & Loop Fasteners		1. Woven Hook & Loop 2. Base Material: Nylon/ Polyester 3. Colour: Black/White 4. Size: 2-inch x 25 Mtr. 5. Application: Orthosis/ Prosthesis	50 Rolls (1 Roll- 25 Mtr.)





95.	PVC Rexin Cloth		<ol style="list-style-type: none"> 1. Quality- 1st Grade 2. PVC coated 3. SAE Rexine Artificial Leather Sheet Fabric 4. Colour: Black/ Skin tone 	200 meter
96.	Dendrite Adhesive		1. Dendrite PC-65 Rubber Adhesive; 2. 01 Liter packet	150 Liter (1 Liter Container)
97.	Rubber Solution- Stag Brand		1. For Leather work	50 Liter (5Liter Container)
98.	Machine Oil		For sewing Machine	5 liter (1 Liter Container)
99.	Nappa Leather for padding		<p>Type: Vegetable tanned leather Raw Material: Cattle Hide Mas/ Skin: 4.5-6.0sqm/45-65 sqft. Thickness: 1.4- 1.6mm Tanning: Chromium –Free/ Vegetable Tensile Strength: 20N/mm Flame Resistance</p>	200 Sq.ft.





100.	Full Grain Chrome Leather for shoe Upper		Size: 10 – 20 sqft. .Thickness: 1.3 – 1.5 mm. Selection: ABC	500 sqft.
101.	Bark Sole Leather/ Sole Leather /Vegetable Tanned Leather		<ol style="list-style-type: none"> 1. Thickness: 3-4mm 2. Material- Buffalo Leather 	75 Kg
102.	Suede Leather		<ol style="list-style-type: none"> 1. Size of skin: 3- 5 sq ft 2. Thickness of skin: 0.5/0.6mm 3. Grain type: Natural Grain 4. For Shoe making; 2. Colour: Different Colour 	500 Sqft
103.	Lining Leather		<ol style="list-style-type: none"> 1. Type- Full Grain chrome free, 2. Thickness- 0.9 to 1.1 mm 3. Tensile Strength- 20 N/m, 4. For Shoe Making; 2. Colour: Skin Tone/ Brown 	500 sqft
104.	Kattai Leather		<ol style="list-style-type: none"> 6. Thickness: 1.5- 1.8mm; 2. Colour: Black/Brown 3. Used for making MCR Chappal, Suspension System 	45 Kg



105.	Leather Board		1. Size: ½ meter x ½ meter x 3mm	15 Nos.
106.	Shoe Lace/Shoe Strings (Round)		1. Material: Cotton Blends, Polyester; 2. Pattern: Pure; 3. Style: Round lace; 4. Colour: Black; 5. Size (Length x Width): 32'' x 0.4''	150 pairs
107.	Shoe Lace/Shoe Strings (Round)		1. Material: Cotton Blends, Polyester; 2. Pattern: Pure; 3. Style: Round lace; 4. Colour: Black; 5. Size(Length x Width): 24'' x 0.4''	150 pairs
108.	Shoe Lace/Shoe Strings (Round)		1. Material: Cotton Blends, Polyester; 2. Pattern: Pure; 3. Style: Round lace; 4. Colour: Brown; 5. Size (Length x Width): 32'' x 0.4''	150 pairs
109.	Shoe Lace/Shoe Strings (Round)		1. Material: Cotton Blends, Polyester; 2. Pattern: Pure; 3. Style: Round lace; 4. Colour: Brown; 5. Size(Length x Width): 24'' x 0.4''	150 pairs
110.	Shoe Lace/Shoe Strings (Flats)		1. Material: Cotton Blends, Polyester; 2. Pattern: Pure; 3. Style: Flat lace; 4. Colour: Brown; 5. Size(Length x Width): 32'' x 0.4''	150 pairs
111.	Eyelets for shoe		1. Material: Metal; 2. Size: Large; 3. Colour: Black	1000 nos.
112.	Eyelets for shoe		1. Material: Metal; 2. Size: Medium; 3. Colour: Black	1000 nos.
113.	Eyelets for shoe		1. Material: Metal; 2. Size: Large; 3. Colour: Silver	1000 nos.

114.	Eyelets for shoe		1. Material: Metal; 2. Size: Large; 3. Colour: Silver	1000 nos.
115.	Shoe Polish- Kiwi/ Cherry Brand		1. Colour: Black; 2. Wax Polish; 3. 40 gm Pkt.	50 nos.
116.	Shoe Polish- Kiwi/ Cherry Brand		1. Colour: Brown; 2. Wax Polish; 3. 40 gm Pkt.	50 nos.
117.	Nigrosine (Polish) Powder		Material Type Wool,Silk,Nylon,Fur,Feathers Types Strong Form Powder, Liquid, Granules Color Black	05 kg (250 g pkt.)
118.	Shoe Polish Brush		1. Soft bristles; 2. Wooden Base; 3. Size(Length x Width x Height): 8.25'' x 2.5'' x 2.25''	25 nos.
119.	Shoe Polish Brush		1. Soft bristles; 2. Wooden Base; 3. Size(Length x Width x Height): 6.25'' x 2.5'' x 2.25''	25 nos.
120.	Shoe Tacks		1. For Shoe making; 2. Material: Iron; 3. Finished: Blue; 4. Flat & round cap, square shaft; 5. Size: 13mm	20 Kg (1 Kg Pkt.)



121.	Shoe Tacks		1. For Shoe making; 2. Material: Iron; 3. Finished: Blue; 4. Flat & round cap, square shaft; 5. Size: 20mm	20 Kg(1 Kg Pkt.)
122.	Leather Shoe Welt		1. Material: Cow Skin; 2. Type: Grain; 3. Thickness: 2mm; 4. Width: 1 cm 5. Pattern: Finished	100 Pcs
123.	Shoe Out sole Sheet		1.Pyramid Pattern Anti-Slip Rubber Mat; 2. Material: Natural Rubber/ SBR; 3. Colour: Black; 4. Size (L x Wx T): 1.5 mtr. x1.5 mtr. X 13mm	25 Sheet
124.	Men Chappal/Sandal Outer sole		Material PVC, Colour- Black, Size – 5 Adult	15 Pairs
125.	Mens Chappal/Sandal Outer sole		Material PVC, Colour- Black, Size – 6 Adult	15 Pairs
126.	Mens Chappal/Sandal Outer sole		Material PVC, Colour- Black, Size – 7 Adult	15 Pairs
127.	Mens Chappal/Sandal Outer sole		Material PVC, Colour- Black, Size – 8 Adult	15 Pairs
128.	Mens Chappal/Sandal Outer sole		Material PVC, Colour- Black, Size – 9 Adult	15 Pairs

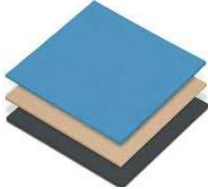
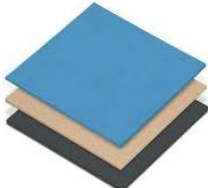





129.	Mens Chappal/Sandal Outer sole		Material PVC, Colour- Black, Size – 10 Adult	15 Pairs
130.	PU adhesive		Dendrite PU Adhesive (01 Litre packet)	15 Liter
131.	PU Adhesive Hardener		PU Hardener	5 Liter
132.	Rubber Ferrule-SQUARE TYPE		For Auxiliary/ Elbow Crutch Tip 1''	100 Pcs
133.	Rubber Ferrule-SQUARE TYPE		For Auxiliary/ Elbow Crutch Tip $\frac{3}{4}$ ''	100 Pcs
134.	Rubber Ferrule-ROUND TYPE		For Auxiliary/ Elbow Crutch tip 1''	250 Pcs
135.	Rubber Ferrule-ROUND TYPE		For Auxiliary/ Elbow Crutch tip $\frac{3}{4}$ ''	250 Pcs
136.	Light Weight sole Raising Sheet (Shalimar)		1. Size (L x W x T): 1.5 mtr. X 1 mtr. 13mm	30 nos.



137.	Light Weight sole Raising Sheet (Shalimar)		1. Size (L x W x T): 1.5 mtr. X 1 mtr. 25mm	55 nos.
138.	Light Weight sole Raising Sheet (Shalimar)		1. Size (L x W x T): 1.5 mtr. X 1 mtr. 50mm	30 nos.
139.	MCR Sole Sheet-FOR DIABETIC FOOT WEAR		1. Micro Cellular Rubber; 2. Size (L x W x T): 20 INCH X 24INCH X 10MM, 3. Colour: Black ,3. shore hardness of 15' Shore 'A'	50 Sheets
140.	MCR Sole Sheet-FOR DIABETIC FOOT WEAR		2. Micro Cellular Rubber; 2. Size (L x W x T) : 20 INCH X 24INCH X 10MM 3. Colour: Brown,3.shore hardness of 15' Shore 'A'	50 Sheets.
141.	MCP (Micro Cellular Polymer)/ EVAZOTE/ PORON 96		5. Sheet Size: 1Mtr. X 2Mtr.x 6mm 6. Colour: Different Colour	50 Sheets
142.	MCP (Micro Cellular Polymer)/ EVAZOTE/ PORON 4000		1. Sheet Size: 1Mtr. X 2Mtr.x 3mm 2. Colour: Different Colour	40 Sheets
143.	EVA foam/ Ethaflex Sheet		1. Size (L x W x T): 1.5 mtr. X 1 mtr. X 1.5 mm; 2. Colour: Different types	75 Sheets
144.	EVA foam/ Ethaflex Sheet		1. Size (L x W x T): 1.5 mtr. X 1 mtr. X 2 mm; 2. Colour: Different types	75 Sheets



145.	EVA foam/ Ethaflex Sheet		1. Size (L x W x T): 1.5 mtr. X 1 mtr. X 3 mm; 2. Colour: Different types	100 Sheets
146.	EVA foam/ Ethaflex Sheet		1. Size (L x W x T): 1.5 mtr. X 1 mtr. X 4 mm; 2. Colour: Different types	75 Sheets
147.	EVA foam/ Ethaflex Sheet		1. Size (L x W x T): 1.5 mtr. X 1 mtr. X 5 mm; 2. Colour: Different types	75 Sheets
148.	Pelite for soft prosthetic Socket		Length *Width= 5 Sq. Mt Thickness=3mm Colour= Brown/ skin tone	30 Sheets
149.	Pelite for soft prosthetic Socket		Length *Width= 5 Sq. Mt Thickness=4mm Colour= Brown/ skin tone	50 Sheets
150.	Plastazote		Length *Width= 5 Sq. Mt Thickness=2mm, 4mm Colour: Different types	20 Sheets each
151.	Aliplast		Length *Width= 5 Sq. Mt Thickness=2mm, 4mm	20 Sheets

152.	Aliplast		Length *Width= 5 Sq. Mt Thickness= 4mm	20 Sheets
153.	PU Foam Ankle Block		Density: 400 plus or minus 5Kg/m3 Size: 1Mtr x ½ mtr x 125mm	20 Nos
154.	PU Foam Socket Block		Density: 180 plus or minus 5Kg/m3 Size: 1Mtr x ½ mtr x 230 mm	20 Nos
155.	Cork Sheet		Thickness: -12mm Length * Width=1meter /1/2 meter	10 Sheet
156.	Cork Sheet		Thickness: 25 mm Length * Width=1meter /1/2 meter	50 Sheet
157.	Foot Impression Block		For taking foot impression of neuropathic foot and other foot deformity Material: PU Foam Size: Standard	200 Pairs
158.	Split Pin- Heavy Duty		1. Brass Plated Steel Pin; 2. Colour: Silver; 3. Size: Shaft length-12 mm; 4. Head: Flat, circular	1000 nos.
159.	Split Pin- Heavy Duty		1. Brass Plated Steel Pin; 2. Colour: Silver; 3. Size: Shaft length-19 mm; 4. Head: Flat, circular	500 nos.
160.	Split Pin- Heavy Duty		1. Brass Plated Steel Pin; 2. Colour: Silver; 3. Size: Shaft length-25 mm; 4. Head: Flat, circular	300 nos.



161.	Prosthetic Button with Hole		Used as suspensor fastner in lower extremity prosthesis Material: Copper Made	100 Nos.
162.	Heavy Duty Cotton Cloth (Canvas) (Dark Maroon for Gaiter)		<ol style="list-style-type: none"> 1. for making gaiter: Colour- Different types 2. Size: (L*B) 50mt *1 Mt 3. Material: Heavy Duty Canvas Cloth (Thick Fabric) 4. GSM: 200 5. Weave Type: Plain Woven Fabric 6. Material: 100 % Cotton 	50 Roll (1 Roll- 50 Mtr.)
163.	Emery Paper/ Sanding Paper		1. Size:4 Inches wide; 2. Grit: 320 (Smooth)	10 Rolls (1 Roll- 5 Mtr.)
164.			1. Size:4 Inches wide; 2. Grit: 180 (Smooth	10 Rolls (1 Roll- 5 Mtr.)
165.			1. Size: 4 inches; 2. Grit: 120 (Smooth)	10 Rolls (1 Roll- 5 Mtr.)
166.			1. Size: 4 inches ; 2. Grit: 100(smooth)	20 Rolls (1 Roll- 5 Mtr.)
167.			1. Size: 4''; 2. Grit: 80 (Rough)	25 Rolls (1 Roll- 5 Mtr.)
168.			1. Size: 4'' ; 2. Grit: 60 (Rough)	15 Rolls (1 Roll- 5 Mtr.)





169.	Hacksaw Blade		1. Material: HSS; 2. Size (Length x Width x Thickness): 300 x 25x 1.25mm; 3. Double side teeth	5 Pkt. (1 Pkt.- 10 Nos.)
170.	Elastic Strap/Band		1. Woven Surgical Elastic; 2. Heat & chemical resistant; 3. Colour: Sin Tone 4. Size: 4''	25 Roll (1 Roll- 5 Mtr.)
171.	Elastic Strap/Band		1. Woven Surgical Elastic; 2. Heat & chemical resistant; 3. Colour: Sin Tone 4. Size: 6''	25 Roll (1 Roll- 5 Mtr.)
172.	Copying Pencil		1. Colour: Violet/Blue	50 Pkt. (1 Pkt.- 10 Nos.)
173.	Glass Marking Pencil		1. Colour: Black/Orange	20 Pkt. (1 Pkt.- 10 Nos.)
174.	Glass Marking Pencil		1. Colour: White	15 Pkt. (1 Pkt.- 10 Nos.)
175.	Surform Blade- Stanley Made		1. Material: Metal; 2. Type: Flat; 3. Cut: Standard	50 nos.
176.	Surform Blade- Stanley Made		1. Material: Metal; 2. Type: Half Round; 3. Cut: Standard	50 nos.

177.	Surform Blade- Stanley Made		1. Material: Metal; 2. Type: Round; 3. Cut: Standard	50 nos.
178.	Twist/ Spiral Drill Bit		1. Material: High Speed Steel; 2. Size: 1/8''	50 nos.
179.	Twist/ Spiral Drill Bit		1. Material: High Speed Steel; 2. Size: 5/32''	50 nos.
180.	Twist/ Spiral Drill Bit		1. Material: High Speed Steel; 2. Size: 1/4''	50 nos.
181.	Twist/ Spiral Drill Bit		1. Material: High Speed Steel; 2. Size: 7/32''	30 nos.
182.	Twist/ Spiral Drill Bit		1. Material: High Speed Steel; 2. Size: 3/16''	50 nos.
183.	Zig Saw Blade		1. Bosch- T123X HSS; 2. Material: BIM; 3. Tooth Design: Side set, milled; 4. Total Length: 100mm; 5. Tooth Spacing: 1.2-2.6mm	30 nos.
184.	Zig Saw Blade- Bosch made		1. Bosch-T244D HCS; 2. Material: high carbon steel; 3. Tooth Design: Side set, milled; 4. Total Length: 100mm; 5. Tooth Spacing: 4-5.2mm; 6. Length of teeth: 74mm	30 nos.
185.	Zig Saw Blade- Bosch Made		1. Bosch-T144D HCS; 2. Material: high carbon steel; 3. Tooth Design: Side set, ground; 4. Total Length: 100mm; 5. Tooth Spacing: 4-5.2mm; 6. Length of teeth: 74mm	30 nos.













186.	Polystyrene		Thickness: 10mm Size: 2 Mtr. X 1 Mtr.	10 Nos.
158	Polystyrene		Thickness: 12 mm Size: 2 Mtr. X 1 Mtr.	10 Nos
159	Polypropylene Orthograde Sheet		Material: Ortho- 'P'- 'RC'- Weight bearing Colour: Natural Size of sheet: 1 Mtr (Width) x 2 Mtr(Length) Thickness: 4mm Quality: Premium	50 Sheets
160	Polypropylene Orthograde Sheet		Material: Ortho- 'Ortho- 'Flex' Non Weight bearing Colour: Natural Size of sheet: 1 Mtr (Width) x 2 Mtr(Length) Thickness: 3 mm Quality: Premium	50 Sheets
161	Polypropylene Orthograde Sheet		Material: Ortho- 'P'- 'RC'- Weight bearing Colour: Natural Size of sheet: 1 Mtr (Width) x 2 Mtr(Length) Thickness: 6mm Quality: Premium	50 Sheets







162.	Polypropylene Orthograde Sheet		Material: Ortho- 'P'- 'RC'- Weight bearing Colour: Natural Size of sheet: 1 Mtr (Width) x 2 Mtr(Length) Thickness: 12mm Quality: Premium	30 Sheets
163.	Polypropylene Orthograde Sheet		Material: Ortho- 'P'- 'RC'- Weight bearing Colour: Natural Size of sheet: 1 Mtr (Width) x 2 Mtr(Length) Thickness: 15mm Quality: Premium	30 Sheets
164.	Polyethylene Sheet		Thickness=3mm Length*Width=1.22mt*2.44mt Colour: Natural	20 Sheets
165.	Polyethylene Sheet		Thickness= 4mm Length*Width=1.22mt*2.44mt Colour: Natural	20 Sheets
166.	LTPP Sheet (Low temperature thermoplastic)		Thickness= 4mm Length*width=1 mtr x 1 mtr Quality: Porous Colour: Skin Tone	20 Sheets
167.	Copolymer Plastic Sheet	Used for Fabrication of Prosthetic Socket and Lower extremity Orthosis	Material: blend of Polypropylene and polyethylene Colour: Natural Size: 2 Mtr (Length) x 1 Mtr (Width) Thickness: 12 mm	20 Sheets

MODULAR BELOW KNEE (BK/TT) PROSTHETIC KIT WITHOUT PROSTETIC FOOT- STAINLESS STEEL MADE					
168	BK/TT Prosthetic kit (For Plastic Lamination)	Kit Components: - Male Socket Adaptor (Pyramid Type)- 01 No.; Female Tube Clamp Adaptor- 01 Nos.; Pylon with female adapter- 01 No.; Foot Adapter with Bolt- 01 No.; Prosthetic Button with Hole (Copper Made)- 04 Nos.; Cosmetic Stocking (Skin Tone)- 02 Nos. Total Components= 10 Nos. MATERIAL= STAINLESS STEEL; WEIGHT BEARING CAPACITY- UP TO 120 Kg.			25 Nos.
169	BK/TT Prosthetic kit (For Plastic Drape)	Kit Components: - Male Socket Adaptor (Pyramid Type)- 01 No.; Female Tube Clamp Adaptor- 01 Nos.; Pylon with female adapter- 01 No.; Foot Adapter with Bolt- 01 No.; Prosthetic Button with Hole (Copper Made)- 04 Nos.; Cosmetic Stocking (Skin Tone)- 02 No. Total Components= 10 Nos. MATERIAL= STAINLESS STEEL; WEIGHT BEARING CAPACITY- UP TO 120 Kg.			125 Nos.
DESCRIPTION DETAILS OF BK/TT PROSTHETIC KITS- STAINLESS STEEL MADE					
			Plastic Lamination Type	Plastic Drape Type	
	Male socket adaptor (Pyramid type)	01 Nos. 			
	Female tube clamp adapter	01 Nos. 			
	Pylon with female adapter	01 No. 			

<p>Foot Adapter with Bolt</p>	<p>01 No.</p> 			
<p>Prosthetic Button with Hole</p>	 <p>04 Nos.</p>			
<p>Cosmetic Stocking (Skin Tone)- 02 Nos</p>	 <p>02 Nos.</p>			



MODULAR BELOW KNEE (BK/TT) PROSTHEITC KIT WITHOUT PROSTHETIC FOOT-ALUMINIUM MADE







170	BK/TT Prosthetic kit (For Plastic Lamination)	Kit Components: - Male Socket Adaptor (Pyramid Type)- 01 No.; Female Tube Clamp Adaptor- 01 Nos.; Pylon with female adapter- 01 No.; Foot Adapter with Bolt- 01 No.; Prosthetic Button with Hole (Copper Made)- 04 Nos.; Cosmetic Stocking (Skin Tone)- 02 Nos. Total Components= 10 Nos. MATERIAL= ALUMINIUM ; WEIGHT BEARING CAPACITY- UP TO 100 Kg.	25 Nos.		
171	BK/TT Prosthetic kit (For Plastic Drape)	Kit Components: - Male Socket Adaptor (Pyramid Type)- 01 No.; Female Tube Clamp Adaptor- 01 Nos.; Pylon with female adapter- 01 No.; Foot Adapter with Bolt- 01 No.; Prosthetic Button with Hole (Copper Made)- 04 Nos.; Cosmetic Stocking (Skin Tone)- 02 No. Total Components= 10 Nos. MATERIAL= ALUMINIUM ; WEIGHT BEARING CAPACITY- UP TO 100 Kg.	75 Nos.		
DESCRIPTION DETAILS OF BK/TT PROSTHETIC KITS- ALUMINIUM MADE					
		Plastic Lamination Type	Plastic Drape Type		
	Male socket adaptor	01 No. 			
	Female tube clamp adaptor	 01 No.			
	Pylon with female adapter	01 No. 			
	Foot Adapter with Bolt	01 Nos. 			

	Prosthetic Button with Holes	 04 Nos.	 		
	Cosmetic Stocking (Skin Tone)- 02 Nos	 02 Nos.	 		
172	Sleeve suspension for Below knee(BK/TT) Prosthesis				100NOS,
173	Stump Sock for Below knee(BK/TT) Prosthesis				100 Nos.
MODULAR ABOVE KNEE (AK/TF) PROSTHETIC KIT WITHOUT PROSTHETIC FOOT- STAINLESS STEEL					
174	AK/TF PROSTHETIC KIT – PLASTIC DRAPE TYPE	Kit Components: - AK Socket Adaptor with Pyramid Receiver - 01 No.; Four –Bar Polycentric Knee Joint- 01 No.; Tube Clamp Adaptor- 01 No.; Pylon with integrated tube Adaptor- 01 No.; Foot Adapter with Bolt- 01 No.; Prosthetic Button with Hole (Copper Made)- 04 Nos.; Cosmetic Stocking (Skin Tone)- 02 Nos.; Cosmetic PU Foam Covering- 01 No. Total Components= 12 Nos.			25 Nos.

		MATERIAL= STAINLESS STEEL ; WEIGHT BEARING CAPACITY- UP TO 120 Kg.	
175	AK/TF PROSTHETIC KIT – PLASTIC LAMINATE TYPE	Kit Components: - Three Prong AK Socket Adaptor with Rotatable Receiver - 01 No.; Four –Bar Polycentric Knee Joint- 01 No.; Tube Clamp Adaptor- 01 Nos.; Pylon with integrated tube Adaptor- 01 No.; Foot Adapter with Bolt- 01 No.; Prosthetic Button with Hole (Copper Made)- 04 Nos.; Cosmetic Stocking (Skin Tone)- 02 Nos.; Cosmetic PU Foam Covering- 01 No. Total Components= 12 Nos. MATERIAL= STAINLESS STEEL ; WEIGHT BEARING CAPACITY- UP TO 120 Kg.	50 Nos.
176	AK/TF PROSTHETIC KIT – PLASTIC LAMINATE TYPE	Kit Components: - Three Prong AK Socket Adaptor with Rotatable Receiver - 01 No.; Four –Bar Polycentric Knee Joint with Integrated tube bar adaptor- 01 No.; Pylon with integrated tube Adaptor- 01 No.; Foot Adapter with Bolt- 01 No.; Prosthetic Button with Hole (Copper Made)- 04 Nos.; Cosmetic Stocking (Skin Tone)- 02 Nos.; Cosmetic PU Foam Covering- 01 No. Total Components= 11 Nos. MATERIAL= STAINLESS STEEL ; WEIGHT BEARING CAPACITY- UP TO 120 Kg.	50 Nos.

DESCRIPTION OF AK/TF PROSTHETIC KITS











			Plastic Drape Type	Plastic Lamination Type
	AK socket Adaptor with Pyramid Receiver	 01 No.	Yes	No
	Socket Adaptor 3 Prong- Pyramid Type	 01 No.	NO	Yes



<p>Four- Bar Polycentric Knee Joint</p>	 01 No.	<p>Yes</p>	<p>Yes</p>
<p>Female tube clamp adapter</p>	 01 No.	<p>Yes</p>	<p>Yes</p>
<p>Pylon with Integrated Tube adapter</p>	 01 No	<p>Yes</p>	<p>Yes</p>
<p>Foot Adaptor with Bolt</p>	 01 No.	<p>Yes</p>	<p>Yes</p>
<p>Prosthetic Button with hole</p>	 04 Nos.	<p>Yes</p>	<p>Yes</p>
<p>Cosmetic Stocking</p>	 02 Nos.	<p>Yes</p>	<p>Yes</p>







THROUGH KNEE DISARTICULATION(KD/TH) PROSTHETIC KIT- STAINLESS STEEL MADE

177	KD/TH PROSTHETIC KIT – PLASTIC LAMINATE TYPE	Kit Components: - Modular Four Bar Polycentric Knee Joint with socket adaptor- 01 No.; Pylon with integrated tube Adaptor- 01 No.; Foot Adaptor with Bolt- 01 No.; Prosthetic Button with Hole (Copper Made)- 04 Nos.; Cosmetic Stocking (Skin Tone)- 02 Nos.; Total Components= 9 Nos. MATERIAL= STAINLESS STEEL ; WEIGHT BEARING CAPACITY- UP TO 120 Kg.	20 Nos.
-----	---	---	---------

DESCRIPTION OF PLASTIC LAMINATION TYPE KD/TH PROSTHEITC KIT

Modular Four Bar Polycentric Knee Joint with socket adaptor	 01 No.				
Female tube clamp adapter	 01 No.				
Pylon with Integrated Tube adapter	 02 No				
Foot Adaptor with Bolt	 01 No.				
Prosthetic Button with hole	 04 Nos.				







	Cosmetic Stocking	 02 Nos.			
178	Total Elastic Suspension (TES) for Above Knee (AK/TF) prosthesis (Right/Left)				100 Nos.
MODULAR HIP DISARTICULATION (HD) PROSTHETIC KIT WITHOUT PROSTHETIC FOOT- STAINLESS STEEL MADE					
179	HD PROSTHETIC KIT – PLASTIC LAMINATE TYPE	Kit Components: - Modular Polycentric Hip Joint with Integrated tube bar adaptor and socket adaptor- 01 No.; Proximal Pylon with integrated tube Adaptor- 01 No.; Four bar polycentric knee joint-01 Nos.; Female tube clamp adapter-01 Nos.; Pylon with integrated ankle adapter-01 Nos.; Foot Adapter with Bolt- 01 No.; Prosthetic Button with Hole (Copper Made)- 04 Nos.; Cosmetic Stocking (Skin Tone)- 02 Nos. Total Components= 12 Nos. MATERIAL= STAINLESS STEEL ; WEIGHT BEARING CAPACITY- UP TO 120 Kg.			15 Nos.
MODULAR HIP DISARTICULATION (HD) PROSTHETIC KIT WITHOUT PROSTHETIC FOOT DESCRIPTION DETAILS					
	Modular Polycentric Hip Joint with Integrated tube bar adaptor and socket adaptor	 01 No.			
	Proximal pylon tube with integrated tube bar adaptor	 01 No.			





	Four-bar prosthetic knee	01 No. 				
	Female tube clamp adapter	01 No. 				
	Pylon with integrated ankle adapter	01 No. 				
	Foot Adapter with bolt	01 No. 				
	Prosthetic Button with Hole	 04 Nos.				
	Cosmetic Stocking	 02 Nos.				
180	Ranger Foot Slim 22 cm Right Wooden Keel , Colour- Skin Texture, Material- Polyurethane, Internal KEEL- Wooden (Injection Molding,, Separate Great toe, Weight Limit- 100 Kg., Nut and Bolt assembly)				10 Nos.	
181	Ranger Foot Slim 22 cm Left Wooden Keel , Colour- Skin Texture, Material- Polyurethane, Internal KEEL- Wooden (Injection Molding,, Separate Great toe, Weight Limit- 100 Kg., Nut and Bolt assembly)				10 Nos.	
182	Ranger Foot Slim 23cm Right Wooden Keel , Colour- Skin Texture, Material- Polyurethane, Internal KEEL- Wooden (Injection Molding,, Separate Great toe, Weight Limit- 100 Kg., Nut and Bolt assembly)				10 Nos.	

183	Ranger Foot Slim 23cm Left Wooden Keel , Colour- Skin Texture, Material- Polyurethane, Internal KEEL- Wooden (Injection Molding,, Separate Great toe, Weight Limit- 100 Kg., Nut and Bolt assembly)	10 Nos.
184	Ranger Foot Slim 24cm Right Wooden Keel , Colour- Skin Texture, Material- Polyurethane, Internal KEEL- Wooden (Injection Molding,, Separate Great toe, Weight Limit- 100 Kg., Nut and Bolt assembly)	10 Nos.
185	Ranger Foot Slim 24cm Left Wooden Keel , Colour- Skin Texture, Material- Polyurethane, Internal KEEL- Wooden (Injection Molding,, Separate Great toe, Weight Limit- 100 Kg., Nut and Bolt assembly)	10 Nos.
186	Ranger Foot Slim 25cm Right Wooden Keel , Colour- Skin Texture, Material- Polyurethane, Internal KEEL- Wooden (Injection Molding,, Separate Great toe, Weight Limit- 100 Kg., Nut and Bolt assembly)	10 Nos.
187	Ranger Foot Slim 25 cm Left Wooden Keel , Colour- Skin Texture, Material- Polyurethane, Internal KEEL- Wooden (Injection Molding,, Separate Great toe, Weight Limit- 100 Kg., Nut and Bolt assembly)	20 Nos.
188	Ranger Foot Slim 26 cm Right Wooden Keel , Colour- Skin Texture, Material- Polyurethane, Internal KEEL- Wooden (Injection Molding,, Separate Great toe, Weight Limit- 100 Kg., Nut and Bolt assembly)	20 Nos.
189	Ranger Foot Slim 26 cm Left Wooden Keel , Colour- Skin Texture, Material- Polyurethane, Internal KEEL- Wooden (Injection Molding,, Separate Great toe, Weight Limit- 100 Kg., Nut and Bolt assembly)	30 Nos.
190	Ranger Foot Slim 27 cm Right Wooden Keel , Colour- Skin Texture, Material- Polyurethane, Internal KEEL- Wooden (Injection Molding,, Separate Great toe, Weight Limit- 100 Kg., Nut and Bolt assembly)	30 Nos.
191	Ranger Foot Slim 27cm Left Wooden Keel , Colour- Skin Texture, Material- Polyurethane, Internal KEEL- Wooden (Injection Molding,, Separate Great toe, Weight Limit- 100 Kg., Nut and Bolt assembly)	30 Nos.
192	Ranger Foot Slim 28 cm Right Wooden Keel , Colour- Skin Texture, Material- Polyurethane, Internal KEEL- Wooden (Injection Molding,, Separate Great toe, Weight Limit- 100 Kg., Nut and Bolt assembly)	30 Nos.
193	Ranger Foot Slim 28 cm Left Wooden Keel , Colour- Skin Texture, Material- Polyurethane, Internal KEEL- Wooden (Injection Molding,, Separate Great toe, Weight Limit- 100 Kg., Nut and Bolt assembly)	25 Nos.

194	Ranger Foot Slim for child (12 & 13 cm) Wooden Keel , Colour- Skin Texture, Material- Polyurethane, Internal KEEL- Wooden (Injection Molding,, Separate Great toe, Weight Limit- 35 Kg., Nut and Bolt assembly)	25 Nos.
195	Jaipur Foot Various sizes with ankle bolt	50 Nos.
196	Jaipur foot various Sizes without ankle bolt	50 Nos.
BODY POWERED BELOW ELBOW (BE/TR) PROSTHETIC KIT		
197	BE/TR PROSTHETIC KIT – ADULT – RIGHT Kit Components: - Mechanical Hand (VO Type)- 01 No.; Cosmetic hand gloves- 01 No.; Quick Disconnect Wrist Unit- 01 No.; Harness System- Figure-8-Type - 01 Nos.; Single Control Cable with Cable Housing kit (with all necessary accessories - 01 No. Total Components= 05 Nos. Material: Stainless steel/ Mild Steel/ Aluminum & High Quality Fabric(Cotton/Nylon)	50 Nos.
198	BE/TR PROSTHETIC KIT – ADULT – LEFT Kit Components: - Mechanical Hand (VO Type)- 01 No.; Cosmetic hand gloves- 01 No.; Quick Disconnect Wrist Unit- 01 No.; Harness System- Figure-8-Type - 01 Nos.; Single Control Cable with Cable Housing kit (with all necessary accessories - 01 No. Total Components= 05 Nos. Material: Stainless steel/ Mild Steel/ Aluminum & High Quality Fabric(Cotton/Nylon)	35 Nos.
199	BE/TR PROSTHETIC KIT – CHILD – RIGHT Kit Components: - Mechanical Hand (VO Type)- 01 No.; Cosmetic hand gloves- 01 No.; Quick Disconnect Wrist Unit- 01 No.; Harness System- Figure-8-Type - 01 Nos.; Single Control Cable with Cable Housing kit (with all necessary accessories - 01 No. Total Components= 05 Nos. Material: Stainless steel/ Mild Steel/ Aluminum & High Quality Fabric(Cotton/Nylon)	20 Nos.
200	BE/TR PROSTHETIC KIT –CHILD – LEFT Kit Components: - Mechanical Hand (VO Type)- 01 No.; Cosmetic hand gloves- 01 No.; Quick Disconnect Wrist Unit- 01 No.; Harness System- Figure-8-Type - 01 Nos.; Single Control Cable with Cable Housing kit (with all necessary accessories - 01 No. Total Components= 05 Nos. Material: Stainless steel/ Mild Steel/ Aluminum & High Quality Fabric (Cotton/Nylon)	15 Nos.



DESCRIPTION OF BODY POWERED BELOW ELBOW (BE/TR) PROSTHETIC KIT







<p>Mechanical Hand (VO) with Rubberized Cover</p>	 <p>01 No.</p>		
<p>Cosmetic Glove-Skin Shade</p>	 <p>01 No.</p>		
<p>Quick Disconnect Wrist Unit</p>	 <p>01 No.</p>		
<p>Harness System-Figure-8-Type</p>	 <p>01 No.</p>		
<p>Single Control Cable system with housing</p>	 <p>01 No.</p>		



	Base Plate Retainer set	 01 No.		
	Cross Bar Assembly	 01 Set		
	Cable to TD Adaptor	 01 Set		
	Hanger	 01 No.		
BODY POWERED ABOVE ELBOW (AE/TH) PROSTHETIC KIT				
201	AE/TH PROSTHETIC KIT – ADULT – RIGHT	Kit Components: - Manually operated Mechanical Elbow Joint – 01 No.; Mechanical Hand (VO Type)- 01 No.; Cosmetic hand gloves- 01 No.; Quick Disconnect Wrist Unit- 01 No.; Harness System- Figure-8-Type with all necessary strap- 01 No.; Forearm Lift Lever Loop- 01 No.; Dual Control Cable with Cable Housing kit (with all necessary accessories - 01 No. Total Components= 07Nos. Material: Stainless steel/ Mild Steel/ Aluminum & High Quality Fabric(Cotton/Nylon)/Leather		50 Nos.
202	AE/TH PROSTHETIC KIT – ADULT – LEFT	Kit Components: - Manually operated Mechanical Elbow Joint – 01 No; Mechanical Hand (VO Type)- 01 No.; Cosmetic hand gloves- 01 No.; Quick Disconnect Wrist Unit- 01 No.; Harness System- Figure-8-Type with all necessary strap - 01 No; Forearm Lift Lever Loop- 01 No; Dual Control Cable with Cable Housing kit (with all necessary accessories - 01 No.		40 Nos.

		Total Components= 07 Nos. Material: Stainless steel/ Mild Steel/ Aluminum & High Quality Fabric(Cotton/Nylon)/Leather	
203	AE/TH PROSTHETIC KIT –CHILD – RIGHT	Kit Components: - Manually operated Mechanical Elbow Joint – 01 No; Mechanical Hand (VO Type)- 01 No.; Cosmetic hand gloves- 01 No.; Quick Disconnect Wrist Unit- 01 No.; Harness System- Figure-8-Type with all necessary strap - 01 No.; Forearm Lift Lever Loop- 01 No; Dual Control Cable with Cable Housing kit (with all necessary accessories - 01 No. Total Components= 07 Nos. Material: Stainless steel/ Mild Steel/ Aluminum & High Quality Fabric(Cotton/Nylon)/Leather	20 Nos.
204	AE/TH PROSTHETIC KIT – CHILD – LEFT	Kit Components: - Manually operated Mechanical Elbow Joint – 01 No; Mechanical Hand (VO Type)- 01 No.; Cosmetic hand gloves- 01 No.; Quick Disconnect Wrist Unit- 01 No.; Harness System- Figure-8-Type with all necessary strap - 01 No.; Forearm Lift Lever Loop- 01 No; Dual Control Cable with Cable Housing kit (with all necessary accessories - 01 No. Total Components= 07 Nos. Material: Stainless steel/ Mild Steel/ Aluminum & High Quality Fabric(Cotton/Nylon)/Leather	15 Nos.



DESCRIPTION OF AE/TH BODY POWERED PROSTHESIS

Internal Locking Mechanical Elbow Unit	 01 No.	
Forearm lift lever loop	 01 No.	
Mechanical Hand with Rubberized Cover (VO)	 01 No.	

<p>Cosmetic Glove- Skin Shade</p>	 <p>01 No.</p>		
<p>Quick Disconnect Wrist Unit</p>	 <p>01No.</p>		
<p>Harness System- Figure-8- type</p>	 <p>01 No.</p>		
<p>Dual Control Cable with housing</p>	 <p>01 No.</p>		
<p>Base Plate Retainer</p>	 <p>01 Set</p>		
<p>Cable to TD Adapter</p>	 <p>01 Set</p>		

	Hanger			
		01 No.		
BODY POWERED SHOULDER DISARTICULATION (SD) PROSTHETIC KIT				
205	SD PROSTHETIC KIT – ADULT – RIGHT	Kit Components: - Manually operated Mechanical Elbow Joint – 01 No.; Single axis Shoulder Joint – 01 No.; Mechanical Hand (VO Type)- 01 No.; Cosmetic hand gloves- 01 No.; Quick Disconnect Wrist Unit- 01 No.; Chest strap & Shoulder Harness System- with all necessary strap- 01 No.; Forearm Lift Lever Loop- 01 No.; Dual Control Cable with Cable Housing kit (with all necessary accessories - 01 No.; Extension amplifier materials – 01 No. Total Components= 09 Nos. Material: Stainless steel/ Mild Steel/ Aluminum & High Quality Fabric(Cotton/Nylon)/Leather		50 Nos.
206	SD PROSTHETIC KIT – ADULT – LEFT	Kit Components: - Manually operated Mechanical Elbow Joint – 01 No.; Single axis Shoulder Joint – 01 No.; Mechanical Hand (VO Type)- 01 No.; Cosmetic hand gloves- 01 No.; Quick Disconnect Wrist Unit- 01 No.; Chest strap & Shoulder Harness System- with all necessary strap- 01 No.; Forearm Lift Lever Loop- 01 No.; Dual Control Cable with Cable Housing kit (with all necessary accessories - 01 No.; Extension amplifier materials – 01 No. Total Components= 09 Nos. Material: Stainless steel/ Mild Steel/ Aluminum & High Quality Fabric(Cotton/Nylon)/Leather		35 Nos.
DESCRIPTION OF BODY POWERED BELOW ELBOW (BE/TR) PROSTHETIC KIT				
	Mechanical Hand (VO) with Rubberized Cover			
		01 No.		

<p>Cosmetic Glove</p>	 <p>01 No.</p>			
<p>Quick Disconnect Wrist Unit</p>	 <p>01 No.</p>			
<p>Internal locking elbow</p>	 <p>01 No.</p>			
<p>Shoulder Bulk Head joint</p>	 <p>01 No.</p>			
<p>Harness System- Figure-8- Type</p>	 <p>01 No.</p>			
<p>Dual Control Cable with housing</p>				

		01 No.			
	Base Plate Retainer	 01 Set			
	Hanger	 01 Set			
	Cable to TD adaptor	 01 No.			

ORTHOTIC COMPONENTS

CONVENTIONAL ANKLE FOOT ORTHOSIS (AFO) KIT WITHOUT SURGICAL SHOE

207	METAL ORTHOTIC AFO KIT (SIZE-1)- RIGHT SIDE	Kit Components: - Side Bar Uprights – 02 Nos.; Calf Band – 01 No.; Ankle joints (Medial & Lateral) - 02 No.; Stirrup Plate= 01 No.; Stirrup Split= 02 Nos. Total Components= 08 Nos. Material: Uprights: - Aluminum; Joints/ Band: Stainless steel/ Mild Steel	50 Nos
208	METAL ORTHOTIC AFO KIT (SIZE-1)- LEFT SIDE	Kit Components: - Side Bar Uprights – 02 Nos.; Calf Band – 01 No.; Ankle joints (Medial & Lateral) - 02 No.; Stirrup Plate= 01 No.; Stirrup Split= 02 Nos. Total Components= 08 Nos. Material: Uprights: - Aluminum; Joints/ Band: Stainless steel/ Mild Steel	50 Nos

209	METAL ORTHOTIC AFO KIT (SIZE-2)- RIGHT SIDE	<p>Kit Components: - Side Bar Uprights – 02 Nos.; Calf Band – 01 No.; Ankle joints (Medial & Lateral) - 02 No.; Stirrup Plate= 01 No.; Stirrup Split= 02 Nos. Total Components= 08 Nos.</p> <p>Material: Uprights: - Aluminum; Joints/ Band: Stainless steel/ Mild Steel</p>	50 Nos
210	METAL ORTHOTIC AFO KIT (SIZE-2)- LEFT SIDE	<p>Kit Components: - Side Bar Uprights – 02 Nos.; Calf Band – 01 No.; Ankle joints (Medial & Lateral) - 02 No.; Stirrup Plate= 01 No.; Stirrup Split= 02 Nos. Total Components= 08 Nos.</p> <p>Material: Uprights: - Aluminum; Joints/ Band: Stainless steel/ Mild Steel</p>	50 Nos
211	METAL ORTHOTIC AFO KIT (SIZE-3)- RIGHT SIDE	<p>Kit Components: - Side Bar Uprights – 02 Nos.; Calf Band – 01 No.; Limited Motion Ankle joints (Medial & Lateral) - 02 No.; Stirrup Plate= 01 No.; Stirrup Split= 02 Nos. Total Components= 08 Nos.</p> <p>Material: Uprights: - Aluminum; Joints/ Band: Stainless steel/ Mild Steel</p>	30 Nos
212	METAL ORTHOTIC AFO KIT (SIZE-3)- LEFT SIDE	<p>Kit Components: - Side Bar Uprights – 02 Nos.; Calf Band – 01 No.; Limited Motion Ankle joints (Medial & Lateral) - 02 No.; Stirrup Plate= 01 No.; Stirrup Split= 02 Nos. Total Components= 08 Nos.</p> <p>Material: Uprights: - Aluminum; Joints/ Band: Stainless steel/ Mild Steel</p>	30 Nos
DESCRIPTION OF ANKLE FOOT ORTHOSIS (AFO) ORTHOTIC KIT (SIZE – 1,2,3)			
	Stirrup Plate	<p>01 No.</p> 	

	Stirrup Split	02 Nos. 		
	Limited motion Ankle Joint	 02 Nos. (Medial & Lateral)		
	Uprights	 02 Nos.		
	Calf band	 01 No.		
CONVENTIONAL METAL KNEE ANKLE FOOT ORTHOSIS (KAFO) KIT WITHOUT SURGICAL SHOE				
213	METAL ORTHOTIC KAFO KIT (SIZE-1)- RIGHT SIDE	Kit Components: - Knee Lower Bar – 02 Nos.; Knee upper Bar – 02.; Drop Lock Knee Joint – 02.; Calf Band – 01 No.; Thigh Band – 01 No.; Tuber Band – 01 No.; Limited Motion Ankle joints (Medial & Lateral) - 02 No.; Stirrup Plate= 01 No.; Stirrup Split= 02 Nos. Total Components= 14 Nos. Material: Uprights: - Aluminum; Joints/ Band: Stainless steel/ Mild Steel		100 Nos

214	METAL ORTHOTIC KAFO KIT (SIZE-1)- LEFT SIDE	Kit Components: - Knee Lower Bar – 02 Nos.; Knee upper Bar – 02.; Drop Lock Knee Joint – 02.; Calf Band – 01 No.; Thigh Band – 01 No.; Tuber Band – 01 No.; Limited Motion Ankle joints (Medial & Lateral) - 02 No.; Stirrup Plate= 01 No.; Stirrup Split= 02 Nos. Total Components= 14 Nos. Material: Uprights: - Aluminum; Joints/ Band: Stainless steel/ Mild Steel	100 Nos
215	METAL ORTHOTIC KAFO KIT (SIZE-2)- RIGHT SIDE	Kit Components: - Knee Lower Bar – 02 Nos.; Knee upper Bar – 02.; Drop Lock Knee Joint – 02.; Calf Band – 01 No.; Thigh Band – 01 No.; Tuber Band – 01 No.; Limited Motion Ankle joints (Medial & Lateral) - 02 No.; Stirrup Plate= 01 No.; Stirrup Split= 02 Nos. Total Components= 14 Nos. Material: Uprights: - Aluminum; Joints/ Band: Stainless steel/ Mild Steel	100 Nos
216	METAL ORTHOTIC KAFO KIT (SIZE-2)- LEFT SIDE	Kit Components: - Knee Lower Bar – 02 Nos.; Knee upper Bar – 02.; Drop Lock Knee Joint – 02.; Calf Band – 01 No.; Thigh Band – 01 No.; Tuber Band – 01 No.; Limited Motion Ankle joints (Medial & Lateral) - 02 No.; Stirrup Plate= 01 No.; Stirrup Split= 02 Nos. Total Components= 14 Nos. Material: Uprights: - Aluminum; Joints/ Band: Stainless steel/ Mild Steel	100 Nos
217	METAL ORTHOTIC KAFO KIT (SIZE-3)- RIGHT SIDE	Kit Components: - Knee Lower Bar – 02 Nos.; Knee upper Bar – 02.; Drop Lock Knee Joint – 02.; Calf Band – 01 No.; Thigh Band – 01 No.; Tuber Band – 01 No.; Limited Motion Ankle joints (Medial & Lateral) - 02 No.; Stirrup Plate= 01 No.; Stirrup Split= 02 Nos. Total Components= 14 Nos. Material: Uprights: - Aluminum; Joints/ Band: Stainless steel/ Mild Steel	50 Nos
218	METAL ORTHOTIC KAFO KIT (SIZE-3)- LEFT SIDE	Kit Components: - Knee Lower Bar – 02 Nos.; Knee upper Bar – 02.; Drop Lock Knee Joint – 02.; Calf Band – 01 No.; Thigh Band – 01 No.; Tuber Band – 01 No.; Limited Motion Ankle joints (Medial & Lateral) - 02 No.; Stirrup Plate= 01 No.; Stirrup Split= 02 Nos. Total Components= 14 Nos. Material: Uprights: - Aluminum; Joints/ Band: Stainless steel/ Mild Steel	50 Nos



DESCRIPTION OF KNEE ANKLE FOOT ORTHOSIS (KAFO) ORTHOTIC KIT (SIZE – 1,2,3)









Stirrup Plate	01 NO.		
Split Stirrup	02 NOS.		
Limited motion Ankle Joint	02 NOS.		
Ankle uprights	02 NOS.		
Knee Lower Bar	02 NOS.		
Drop Lock Knee Joint	 02 NOS.		
Knee Upper Bar	02 NOS.		
Calf band	01 NO.		
Thigh band	01 NO.		

	Tuber Band	 01 NO.		
CONVENTIONAL METAL HIP KNEE ANKLE FOOT ORTHOSIS (HKAFO) KIT WITHOUT SURGICAL SHOE				
219	METAL ORTHOTIC HKAFO KIT (SIZE-1)- RIGHT SIDE	<p>Kit Components: - Knee Lower Bar – 02 Nos.; Knee upper Bar – 02.; Drop Lock Hip Joint with Bars – 01 No.; Drop Lock Knee Joint – 02.; Calf Band – 01 No.; Thigh Band – 01 No.; Tuber Band – 01 No.; Pelvic Band – 01 No.; Limited Motion Ankle joints (Medial & Lateral) - 02 No.; Stirrup Plate= 01 No.; Stirrup Split= 02 Nos. Total Components= 16 Nos.</p> <p>Material: Uprights: - Aluminum; Joints/ Band: Stainless steel/ Mild Steel</p>		100 Nos
220	METAL ORTHOTIC HKAFO KIT (SIZE-1)- LEFT SIDE	<p>Kit Components: - Knee Lower Bar – 02 Nos.; Knee upper Bar – 02.; Drop Lock Hip Joint with Bars – 01 No.; Drop Lock Knee Joint – 02.; Calf Band – 01 No.; Thigh Band – 01 No.; Tuber Band – 01 No.; Pelvic Band – 01 No.; Limited Motion Ankle joints (Medial & Lateral) - 02 No.; Stirrup Plate= 01 No.; Stirrup Split= 02 Nos. Total Components= 16 Nos.</p> <p>Material: Uprights: - Aluminum; Joints/ Band: Stainless steel/ Mild Steel</p>		100 Nos
221	METAL ORTHOTIC HKAFO KIT (SIZE-2)- RIGHT SIDE	<p>Kit Components: - Knee Lower Bar – 02 Nos.; Knee upper Bar – 02.; Drop Lock Hip Joint with Bars – 01 No.; Drop Lock Knee Joint – 02.; Calf Band – 01 No.; Thigh Band – 01 No.; Tuber Band – 01 No.; Pelvic Band – 01 No.; Limited Motion Ankle joints (Medial & Lateral) - 02 No.; Stirrup Plate= 01 No.; Stirrup Split= 02 Nos. Total Components= 16 Nos.</p> <p>Material: Uprights: - Aluminum; Joints/ Band: Stainless steel/ Mild Steel</p>		75 Nos
221	METAL ORTHOTIC HKAFO KIT	<p>Kit Components: - Knee Lower Bar – 02 Nos.; Knee upper Bar – 02.; Drop Lock Hip Joint with Bars – 01 No.; Drop Lock Knee Joint – 02.; Calf Band – 01 No.; Thigh Band – 01 No.; Tuber Band – 01 No.; Pelvic</p>		75 Nos

	(SIZE-2)- LEFT SIDE	<p>Band – 01 No.; Limited Motion Ankle joints (Medial & Lateral) - 02 No.; Stirrup Plate= 01 No.; Stirrup Split= 02 Nos.</p> <p>Total Components= 16 Nos.</p> <p>Material:</p> <p>Uprights: - Aluminum; Joints/ Band: Stainless steel/ Mild Steel</p>	
223	METAL ORTHOTIC HKAFO KIT (SIZE-3)- RIGHT SIDE	<p>Kit Components: - Knee Lower Bar – 02 Nos.; Knee upper Bar – 02.; Drop Lock Hip Joint with Bars – 01 No.; Drop Lock Knee Joint – 02.; Calf Band – 01 No.; Thigh Band – 01 No.; Tuber Band – 01 No.; Pelvic Band – 01 No.; Limited Motion Ankle joints (Medial & Lateral) - 02 No.; Stirrup Plate= 01 No.; Stirrup Split= 02 Nos.</p> <p>Total Components= 16 Nos.</p> <p>Material:</p> <p>Uprights: - Aluminum; Joints/ Band: Stainless steel/ Mild Steel</p>	50 Nos
224	METAL ORTHOTIC HKAFO KIT (SIZE-3)- LEFT SIDE	<p>Kit Components: - Knee Lower Bar – 02 Nos.; Knee upper Bar – 02.; Drop Lock Hip Joint with Bars – 01 No.; Drop Lock Knee Joint – 02.; Calf Band – 01 No.; Thigh Band – 01 No.; Tuber Band – 01 No.; Pelvic Band – 01 No.; Limited Motion Ankle joints (Medial & Lateral) - 02 No.; Stirrup Plate= 01 No.; Stirrup Split= 02 Nos.</p> <p>Total Components= 16 Nos.</p> <p>Material:</p> <p>Uprights: - Aluminum; Joints/ Band: Stainless steel/ Mild Steel</p>	50 Nos





DESCRIPTION OF METAL HIP KNEE ANKLE FOOT ORTHOSIS (HKAFO) ORTHOTIC KIT (SIZE – 1,2,3)

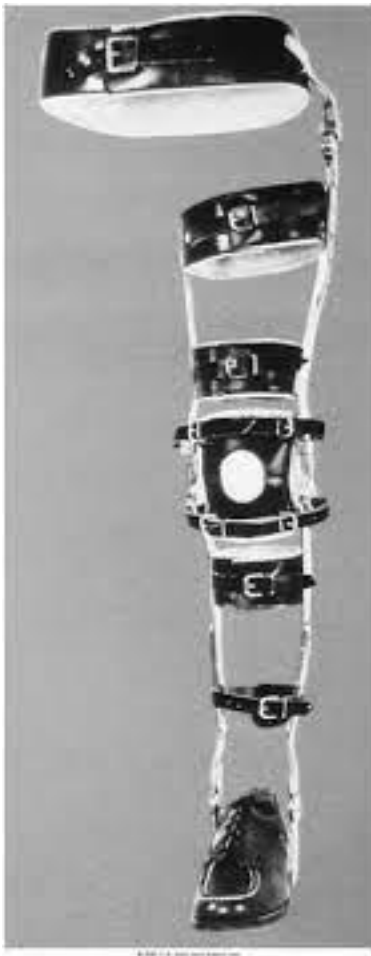



	Stirrup Plate	01 No.		
	Split Stirrup	02 Nos.		
	Limited motion Ankle Joint	02 Nos.		







Ankle uprights	02 Nos.	
Knee Lower Bar	02 Nos.	
Drop Lock Knee Joint	02 Nos.	
Knee Upper Bar	02 Nos.	
Calf band	01 No.	
Thigh band	01 No.	
Tuber Band	01 No.	
Drop Lock Hip Joint with Upright	01 No.	
Pelvic Band	01 No.	















ORTHOTIC COMPONENTS ACCESSORIES



225	Free Motion Ankle Joint with stirrup split- size I (Medial & Lateral)			50 Pairs
226	Free Motion Ankle Joint with stirrup split - size II (Medial & Lateral)			50 Pairs
227	Free Motion Ankle Joint with stirrup split- size III (Medial & Lateral)			50 Pairs
228	Limited Motion Ankle joint with stirrup split- For AFO, KAFO & HKAFO KIT Size- 1 (Medial & Lateral)			50 Pairs
229	Limited Motion Ankle joint with stirrup split- For AFO, KAFO & HKAFO KIT Size- II(Medial & Lateral)			50 Pairs

230	Limited Motion Ankle joint with stirrup split- For AFO, KAFO & HKAFO KIT Size- 1II(Medial & Lateral)			50 Pairs
231	Foot Drop Ankle joint with stirrup split- For AFO, KAFO & HKAFO KIT Size- I (Medial & Lateral)			50 Pairs
232	Foot Drop Ankle joint with stirrup split - For AFO, KAFO & HKAFO KIT Size- II(Medial & Lateral)			50 Pairs .
233	Foot Drop Ankle joint with stirrup split - For AFO, KAFO & HKAFO KIT Size- III(Medial & Lateral)			50 Pairs
234	Double Action Ankle joint with stirrup split - For AFO, KAFO & HKAFO KIT Size- 1(Medial & Lateral)			50 Pairs
235	Double Action Ankle joint with stirrup split - For AFO, KAFO & HKAFO KIT Size- II(Medial & Lateral)			50 Pairs
236	Double Action Ankle joint with stirrup split - For AFO, KAFO & HKAFO KIT Size- 1II(Medial & Lateral)			50 Pairs



237	Tamarack Flexure Joint –Free Motion			200 Nos.
238	Tamarack Flexure Joint Dorsiflexion Assist			100 Nos.
239	Polypropylene Oklahoma Ankle Joint-Small and Adult Size			100 Nos.
240	Drop Lock Knee Joint Size-I For Conventional KAFOs & HKAFOs			100 Nos.
241	Drop Lock Knee Joint Size-II For Conventional KAFOs & HKAFOs			100 Nos.
242	Drop Lock Knee Joint Size-III For Conventional KAFOs & HKAFOs			100 Nos.

243	<p align="center">Posterior Offset Knee Joint Size-I For Conventional KAFOs & HKAFOs</p>			<p align="center">50 Nos.</p>
244	<p align="center">Posterior Offset Knee Joint Size-II For Conventional KAFOs & HKAFOs</p>			<p align="center">50 Nos.</p>
245	<p align="center">Posterior Offset Knee Joint Size-II For Conventional KAFOs & HKAFOs</p>			<p align="center">50 Nos.</p>
246	<p align="center">Polycentric Knee Joint Size-I For Conventional KAFOs & HKAFOs</p>			<p align="center">50 Nos.</p>
247	<p align="center">Polycentric Knee Joint Size-II For Conventional KAFOs & HKAFOs</p>			<p align="center">50 Nos.</p>
248	<p align="center">Polycentric Knee Joint Size-III For Conventional KAFOs & HKAFOs</p>			<p align="center">50 Nos.</p>

249	Spring lever knee Joint Size-I For Conventional KAFOs & HKAFOs			50 Nos.
250	Spring lever knee Joint Size-II For Conventional KAFOs & HKAFOs			50 Nos.
251	Spring lever knee Joint Size-III For Conventional KAFOs & HKAFOs			50 Nos.
252	Load Response Knee Joint			20 Nos.
253	Hip Joint Drop Lock Size-I For Conventional HKAFOs			100 Nos.
254	Hip Joint Drop Lock Size-II For Conventional HKAFOs			50 Nos.

255	Hip Joint Drop Lock Size-III For Conventional HKAFOs			50 Nos.
257	Stirrup Plate- Right Size- Small, Medium & Large			100 nos.
258	Stirrup Plate- Left Size- Small, Medium & Large			100 nos.
259	Splint C/Foot with D.B. Shoe Extra Small			50 Nos.
260	Splint C/Foot with D.B. Shoe Small			50 Nos.
261	Splint C/Foot with D.B. Shoe Medium			30 Nos.
262	Milwaukee Brace- Spinal Orthosis Kits Size- Child			20 Nos.
263	Milwaukee Brace- Spinal Orthosis Kits Size- Adult			20 Nos.
264	SOMI Brace Kit- Adult Size			25 Nos.
265	Anterior Spinal Hyperextension Brace- Adult Size			25 Nos.

266	Soft Cervical Collar- Standard Size	50 Nos.
267	Rigid Cervical Collar (Philadelphia Collar)	50 Nos.
268	Porous Low temperature thermoplastic sheet- 2mm Thickness Sheet Size- 2mtr.X1 mtr. Colour- Skin tone	15 Sheets
269	Porous Low temperature thermoplastic sheet- 3mm Thickness Sheet Size- 2mtr.X1 mtr. Colour- Skin tone	15 Sheets
270	Porous Low temperature thermoplastic sheet- 4mm Thickness Sheet Size- 2mtr.X1 mtr. Colour- Skin tone	05 Sheets
271	Knee sleeve (Small, Medium, Large) (Neoprene rubberized material)	200 Nos.
272	Elbow sleeve (Small, Medium, Large)	100 Nos
273	Elastic Band (1.5 width) ; Colour- Black/ Skin Tone	100 Mtrs
274	Elastic Band (2 inches width); Colour- Black/ Skin Tone	100 Mtrs
275	Elastic Band (4 inches width); Colour- Black/ Skin Tone	100 Mtrs
276	Cosmetic Gloves with Zipper design (For Upper Limb Prosthesis) – Right Side Adult	20 Nos.

277	Cosmetic Gloves with Zipper design (For Upper Limb Prosthesis) – Left Side Adult	20 Nos.
278	Cosmetic PU Foam Covering – BK  (Semi Rigid Foam)	100 Nos.
279	Cosmetic PU Foam Covering – AK  (Soft Foam)	75 Nos.

Important Note:

The vendors may be asked to produce sample of quoted materials to qualify technically during technical evaluation process. Non production sample will resulting in rejection of said material technically. Financially qualified bidders will be submitting one set of each qualified item as sample to NIEPMD for entire currency of contract. No cost will be paid for Samples; samples will have been returned to supplier on closing of contract.

Special Terms & Conditions:

1. The bidder should have their own agency facility. Proof to be uploaded with the Tech Bid.
2. The bidder should have an average annual minimum turnover of **Rs. 50 Lakh** for last 05 financial years (i.e. atleast Rs. 2.5 crores during last 05 FYs.). Proof of certificate for turnover is required to be uploaded with the tender (CA attested copy of the balance sheet with profit & loss statement of last 05 FYs.)
3. The applying firm must be registered with the GSTIN / Sales Tax / Value Added Tax and the supporting proof for the same is to be uploaded.
4. Tenderer should upload for last 05 FYs income tax return copies ending on 31st March 2020.
5. The bidder must have minimum 05 years' experience in present business, proof of 05 years' experience and in businesses should be uploaded with technical bid. Bidders should provide brief profile of their work experience for the last five years along with the relevant samples of the similar work done earlier.
6. Must have minimum 05 years' experience in the field of supplying **Prosthetics & Orthotics (P&O) Components & Raw Materials** to any government agency / PSU/ autonomous bodies. Proof of experience in form of supply orders / delivery challans / contract awarding letter may be uploaded.
7. The materials should be delivered at NIEPMD, Chennai and its Composite Regional Centers (CRCs). Transportation charges in the cheapest mode (Until otherwise instructed) will be paid on production of original transportation invoices.
8. **The total cost quoted should be exclusive of taxes. Applicable taxes to be mentioned separately. Tax applicable at the time of invoice will be paid.**
9. NIEPMD reserves the right to accept / reject / select more than one Agency. And to annul the bidding process of any or all bids at any time prior to award of contract without thereby incurring any liability to the affected bidders.
10. Product images uploaded in scope of work are for reference purpose only, however tender document does not recommending for any specific brand/make/ manufacturer. In case if any seems to be like this it will be a co-incident only.
11. In case of any query / clarification regarding items technical specification please contact on mobile No. 8072267210.
12. **The successful bidder will be required to execute a performance security of 10% (ten percent) of the value of the contract in form of fixed Deposit with bank with lien made until the contract is over or one year, whichever is later.**
13. In case of not depositing or showing inefficiency to deposit the performance security after successfully qualifying, the proposal will be treated as cancelled.

We agree to all terms and conditions as mentioned above including the validity of the offer.

Utmost confidentiality of the data provided shall be maintained.

Name, Designation & Signature of the bidder with the seal

CHECK LIST

The Technical Bid shall be summarily rejected, if these documents are not uploaded. Documents must be attached in following serial order only.

Sl. No.	Particulars	Yes / No
1.	EMD Amount of Rs.50,000/- (receipts of online payment be uploaded with technical bid)	
2.	Proof of average annual turnover of last 05 financial years Rs. 50/-Lac (I.e. 2.5 Crores in 05 FYs) (CA certified copies and profit and loss statement with balance sheet to be uploaded with technical bid)	
3.	Copy of appropriate PAN Card (be uploaded with technical bid)	
4.	Copy of Registration with Service Tax/ Sales Tax/ VAT Department. (be uploaded with technical bid)	
5.	Copy of GSTIN Certificate (GSTIN should be active mode)	
6.	Technical Specification of materials quoted in respect to our tender document. (Serial No. & Name of Item, Page No.) as per appendix "B"	
7.	Undertaking to supply on credit of 30 days after clear receipt of materials (be uploaded with technical bid)	
8.	Proof of having own agency facility. (Proof to be uploaded)	
9.	Copies of supply orders / challans / contract award letter of authentic agencies as proof of in same business.	
10.	Self-certification that firm is not blacklisted / debarred during last 05 years.	
11.	Undertaking regarding rates will be firm during contract period. (Self-Certificate on company letter head to be uploaded)	
12.	Copy of Income Tax Return of the firm/company/agency (Individual in case sole proprietary firm) for last 05 financial years.	
13.	Copy of NIT duly signed and stamped by the bidder on all pages Must be uploaded.	
14.	<p>The Bidder must either be the Original Equipment Manufacturer (OEM) or an authorized dealer. In case of OEM, Proof of being Original Equipment Manufacturer (OEM) or authorized dealer must be uploaded</p> <p style="text-align: center;">OR</p> <p>In case of authorized representative of OEM - current authorization from the OEM must be uploaded.</p> <p style="text-align: center;">OR</p> <p>In case of Authorised distributor of OEM detailed and valid agreement between Distributor and the OEM(s) defining clearly the role, responsibility, scope of work and contribution towards the tendered Equipment/System for each OEM(s).must be uploaded.</p>	
15.	Agreed with Important note on page No. 66 regarding providing samples of quoted materials	

**NATIONAL INSTITUTE FOR EMPOWERMENT OF PERSONS
WITH MULTIPLE DISABILITIES (NIEPMD)**

(Department of Empowerment of Persons with Disabilities,
Ministry of Social Justice & Empowerment, Govt. of India)

East coast Road, Muttukadu, Kovalam(post) Chennai-603 112

Tel:044-27472113,274720 46 Fax:044-27472389

www.niepmd.tn.nic.in Email:niepmd@mail.com

FINANCIAL BID

- (a) BOQ in excel format provided with tender document should be downloaded and filled up as per details in BOQ document. No commercial quote should be mentioned in technical bid. In case mentioning commercial quotes with technical bid will leads in rejection of tender document.

Signature and seal of the bidder